

Fasteners for Sheet Metal

Product Brochure



part of the Trifast plc Group





Self Clinch Fasteners		4-11	Self Clinch Fasteners		4-11
Flush Head Stud - TR-FH/TR-FHS/TR-FHA/TR-FH4	4	Grounding Standoff - TR-SOSG	8		
Concealed Head Stud for 1.6mm Sheet - TR-CHC/TR-CHA	4	Clip-on Standoff - TR-SSS/TR-SSC/TR-SSA	8		
Concealed Head Stud for 2.4mm Sheet - TR-CFHC/TR-CFHA	4	Broaching Through Hole Standoff - TR-KFE/TR-KFSE	9		
Heavy Duty Stud - TR-HFH/TR-HFHS	4	Broaching Threaded Standoff - TR-KFE/TR-KFSE	9		
Low Displacement Stud - TR-FHL/TR-FHLS	4	Thin Sheet Standoff - TR-TSO/TR-TSOS	9		
Broaching Stud - TR-KFH	4	Clear Hole Standoff - TR-SO	9		
Thin Sheet Stud - TR-TFH	5	Slotted Panel Fastener - TR-PFS2/TR-PFC2	9		
Heavy Duty Thin Sheet Stud - TR-HFE	5	Cross Recess Panel Fastener - TR-PFC2P	9		
Nut - TR-S/TR-CLS/TR-CLA/TR-SP4/TR-SP2	5	Low Profile Panel Fastener - TR-PF30/TR-PF31/TR-PF32	10		
Flush Nut - TR-F/TR-F4	5	Pin Panel Fastener - TR-PTL2	10		
Blind Nut - TR-B/TR-BS	5	Captive Screw Panel Fastener - TR-PF11	10		
Broaching Nut - TR-KF2/TR-KFS2	5	Captive Screw Panel Fastener - TR-PFHV	10		
Non-Locking Floating Nut - TR-AS/TR-AC	6	Low Profile Cross Recess Panel Fastener - TR-PF50	10		
Locking Floating Nut - TR-LAS/TR-LAC	6	Flush Head Pin - TR-TP/TR-TPS/TR-TP4	10		
Locking Nut - TR-LK/TR-LKS	6	Terminal Pin - TR-TER	11		
Nylon Lock Nut - TR-PL/TR-PLC	6	Cable Tie Mount - TR-TD	11		
Non-Locking Mini Nut - TR-U/TR-FEX/TR-FEOX	6	EPW Self-Extruding Screw - TR-EPW	11		
Self-Locking Mini Squeezed Nut - TR-UL/TR-FE/TR-FEO	6				
Thin Sheet Nut - TR-SMPS	7	Hank® Rivet Bushes 12-13			
Nylon Insert Broaching Nut - TR-CFN	7	Round Serrated Face	12		
Thread Lock Feature Nut - TR-SL	7	Mini Round Serrated Face	12		
Non-Locking H Nut - TR-H	7	Round Serrated Spigot	12		
Blind Standoff - TR-BSO/TR-BSOS/TR-BSOA/TR-BSO4	7	Hexagon	12		
Through Standoff - TR-SO/TR-SOS/TR-SOA/TR-SO4	7	Mini Round Euro	12		
Concealed Head Standoff for 1.6mm Sheet - TR-CSS	8	Round Euro	12		
Concealed Head Standoff for 2.4mm Sheet - TR-CSOS	8	Standoff Serrated Face	13		
Hole Slide Standoff - TR-SKC	8	Mini Standoff Serrated Face	13		
Close To Edge Standoff - TR-DSO/TR-DSOS	8	Tank	13		
		Swage Nut	13		

Blind Rivet Nuts 14-15

Knurled Body Reduced Head - Open End	14
Knurled Body Reduced Head - Closed End	14
Plain Body Reduced Head - Open End	14
Plain Body Reduced Head - Closed End	14
Hexagon Body Reduced Head - Open End	14
Knurled Body Flange Head - Open End	14
Knurled Body Flange Head - Closed End	15
Hexagon Body Flange Head - Open End	15
Knurled Body Countersunk Head - Open End	15

Blind Rivets 16-17

Open Type Dome Head	16
Open Type Countersunk Head	16
Open Type Large Flange Head	16
Sealed Type Dome Head	16
Sealed Type Countersunk Head	16
Sealed Type Large Flange Head	16
Multi-Grip Type Dome Head	16
Multi-Grip Type Countersunk Head	17
Multi-Grip Type Large Flange Head	17
Peel Type Dome Head	17
Grooved Type Dome Head	17

Weld Nuts 18

Hexagon Weld Nut	18
Square Weld Nut	18
Wun-Loc® Self Locking Weld Nut	18

K-Series® Nuts 18

K-Series® Nut	18
K-Series® Thin Nut	18

CD Weld Studs 19

Threaded CD Weld Stud	19
Unthreaded CD Weld Stud	19
Internally Threaded CD Weld Stud	19
Coarse Threaded CD Weld Stud	19

Masking Caps & Plugs 19

Masking Caps	19
Masking Plugs	19

Spring Steel Fasteners 20

Cage Nut	20
U Nut	20
J Nut	20
Flat Nut	20
Torque Nut	20
Multi Thread U Nut	20

Solid & Tubular Rivets 21

Round Head Solid Rivet	21
Flat Round Head Solid Rivet	21
Countersunk Head Solid Rivet	21
Tubular Rivet	21

Core product range 22-23

Standard Fasteners	22
Fasteners for Plastic	22
Plastic Hardware	22
Spacers and Pillars	22
Security Fasteners	23
Enclosure Hardware	23
Tooling and Driver Bits	23
Bespoke Products	23

Wun-Loc® is a registered trademark of TR Fastenings.



Flush Head Stud TR-FH/TR-FHS/TR-FHA/TR-FH4

Category: Self Clinch Fastener

Product: Stud

Type: Flush Head

Material: Steel (TR-FH), Stainless Steel (TR-FHS), Aluminium (TR-FHA), 400 Stainless Steel (TR-FH4)

Thread: M2, M2.5, M3, M4, M5, M6, M8

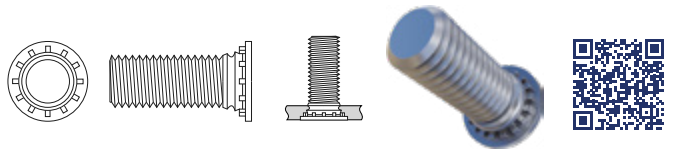

www.trfastenings.com/TR00028536

Concealed Head Stud for 1.6mm Sheet TR-CHC/TR-CHA

Category: Self Clinch Fastener

Product: Stud

Type: Concealed Head

Material: Stainless Steel (TR-CHC), Aluminium (TR-CHA)

Thread: M3, M4, M5

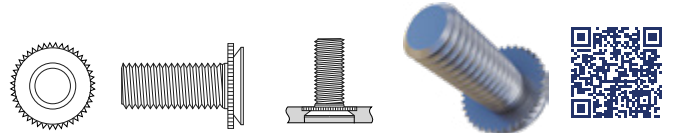

www.trfastenings.com/TR00028454

Concealed Head Stud for 2.4mm Sheet TR-CFHC/TR-CFHA

Category: Self Clinch Fastener

Product: Stud

Type: Concealed Head

Material: Stainless Steel (TR-CFHC), Aluminium (TR-CFHA)

Thread: M3, M4, M5

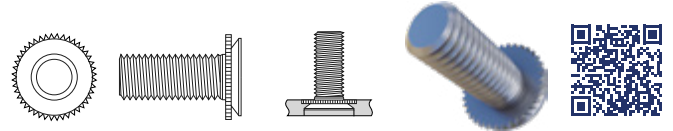

www.trfastenings.com/TR00028495

Heavy Duty Stud TR-HFH/TR-HFHS

Category: Self Clinch Fastener

Product: Stud

Type: Heavy Duty

Material: Steel (TR-HFH), Stainless Steel (TR-HFHS)

Thread: M5, M6, M8, M10

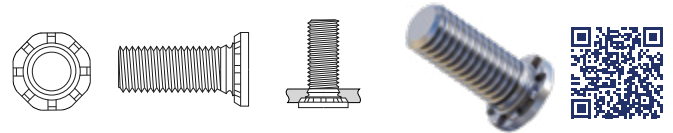

www.trfastenings.com/TR00029165

Low Displacement Stud TR-FHL/TR-FHLS

Category: Self Clinch Fastener

Product: Stud

Type: Low Displacement

Material: Steel (TR-FHL), Stainless Steel (TR-FHLS)

Thread: M2.5, M3, M4, M5

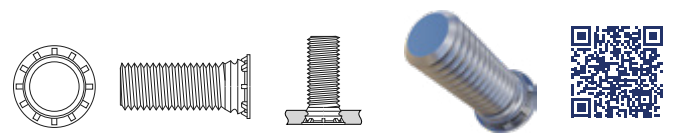

www.trfastenings.com/TR00029270

Broaching Stud TR-KFH

Category: Self Clinch Fastener

Product: Stud

Type: Broaching

Material: Phosphor Bronze (TR-KFH)

Thread: M2.5, M3, M4, M5

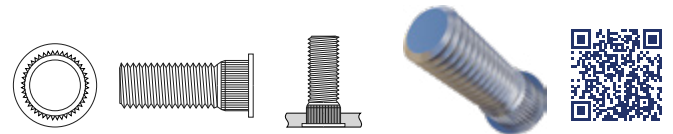

www.trfastenings.com/TR00028436

Self Clinch Fasteners



Thin Sheet Stud TR-TFH

Category: Self Clinch Fastener
 Product: Stud
 Type: Thin Sheet
 Material: Steel (TR-TFH)
 Thread: M3, M4, M5

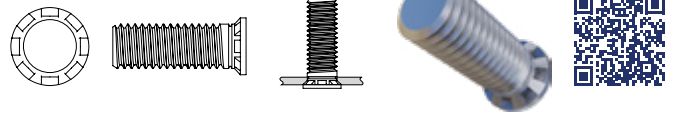

www.trfastenings.com/TR00029427

Heavy Duty Thin Sheet Stud TR-HFE

Category: Self Clinch Fastener
 Product: Stud
 Type: Heavy Duty Thin Sheet
 Material: Steel (TR-HFE)
 Thread: M5, M6, M8

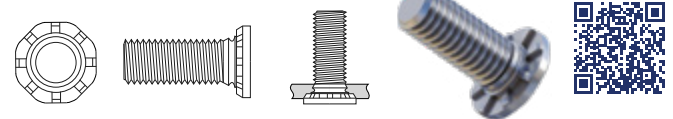

www.trfastenings.com/TR00038778

Nut TR-S/TR-CLS/TR-CLA/TR-SP4/TR-SP2

Category: Self Clinch Fastener
 Product: Nut
 Type: Nut
 Material: Steel (TR-S), Stainless Steel (TR-CLS), Aluminium (TR-CLA), 400 Stainless Steel (TR-SP4), A286 Stainless Steel (TR-SP2)
 Thread: M2, M2.5, M3, M3.5, M3 Alt, M4, M5, M6, M8, M10, M12

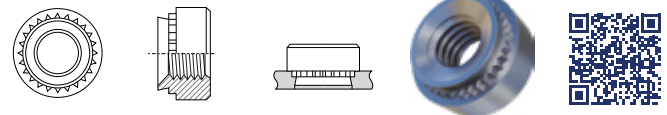

www.trfastenings.com/TR00029909

Flush Nut TR-F/TR-F4

Category: Self Clinch Fastener
 Product: Nut
 Type: Flush
 Material: Stainless Steel (TR-F), 400 Series Stainless Steel (TR-F4)
 Thread: M2, M2.5, M3, M3.5, M3 Alt, M4, M5, M6

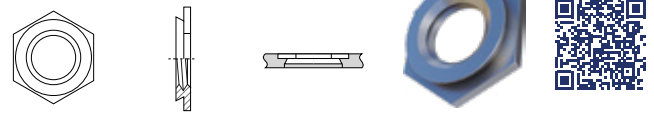

www.trfastenings.com/TR00029891

Blind Nut TR-B/TR-BS

Category: Self Clinch Fastener
 Product: Nut
 Type: Blind
 Material: Steel (TR-B), Stainless Steel (TR-BS)
 Thread: M3, M4, M5, M6

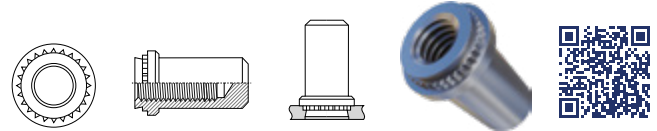

www.trfastenings.com/TR00029825

Broaching Nut TR-KF2/TR-KFS2

Category: Self Clinch Fastener
 Product: Nut
 Type: Broaching
 Material: Steel (TR-KF2), Stainless Steel (TR-KFS2)
 Thread: M2, M2.5, M3, M3.5, M4, M5



www.trfastenings.com/TR00029866



Non-Locking Floating Nut TR-AS/TR-AC

Category: Self Clinch Fastener

Product: Nut

Type: Non-Locking Floating

Material: Steel (TR-AS), Stainless Steel (TR-AC)

Thread: M3, M4, M5, M6



www.trfastenings.com/TR00026768

Locking Floating Nut TR-LAS/TR-LAC

Category: Self Clinch Fastener

Product: Nut

Type: Locking Floating Nut

Material: Steel (TR-LAS), Stainless Steel (TR-LAC)

Thread: M3, M4, M5, M6



www.trfastenings.com/TR00026731

Locking Nut TR-LK/TR-LKS

Category: Self Clinch Fastener

Product: Nut

Type: Locking

Material: Steel (TR-LK), Stainless Steel (TR-LKS)

Thread: M2.5, M3, M4, M5

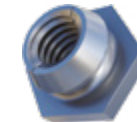

www.trfastenings.com/TR00030200

Nylon Lock Nut TR-PL/TR-PLC

Category: Self Clinch Fastener

Product: Nut

Type: Nylon Lock Nut

Material: Steel (TR-PL), Stainless Steel (TR-PLC)

Thread: M3, M4, M5



www.trfastenings.com/TR00030217

Non-Locking Mini Nut TR-U/TR-FEX/TR-FEOX

Category: Self Clinch Fastener

Product: Nut

Type: Non-Locking Mini Nut

Material: Steel (TR-U/TR-FEX/TR-FEOX)

Thread: M2, M3, M4, M5, M6



www.trfastenings.com/TR00030224

Self-Locking Mini Squeezed Nut TR-UL/TR-FE/TR-FEO

Category: Self Clinch Fastener

Product: Nut

Type: Self-Locking Mini Squeezed

Material: Stainless Steel (TR-UL/TR-FE/TR-FEO)

Thread: M2, M3, M4, M5, M6



www.trfastenings.com/TR00030233

Self Clinch Fasteners



Thin Sheet Nut TR-SMPS

Category: Self Clinch Fastener

Product: Nut

Type: Thin Sheet

Material: 300 Series Stainless Steel (TR-SMPS)

Thread: M2.5, M3, M3.5



www.trfastenings.com/TR00039596

Nylon Insert Broaching Nut TR-CFN

Category: Self Clinch Fastener

Product: Nut

Type: Nylon Insert Broaching

Material: Steel (TR-CFN)

Thread: M3



www.trfastenings.com/TR00044323

Thread Lock Feature Nut TR-SL

Category: Self Clinch Fastener

Product: Nut

Type: Thread Lock Feature

Material: Steel (TR-SL)

Thread: M3, M3.5, M4, M5, M6, M8

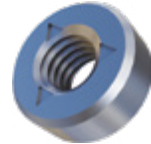

www.trfastenings.com/TR00044325

Non-Locking H Nut TR-H

Category: Self Clinch Fastener

Product: Nut

Type: Non-Locking H

Material: Steel (TR-H)

Thread: M10



www.trfastenings.com/TR00039594

Blind Standoff TR-BSO/TR-BSOS/TR-BSOA/TR-BSO4

Category: Self Clinch Fastener

Product: Standoff

Type: Blind

Material: Steel (TR-BSO), Stainless Steel (TR-BSOS), Aluminium (TR-BSOA), 400 Stainless Steel (TR-BSO4)

Thread: M2, M2.5, M3, M3 Alt, M4, M5

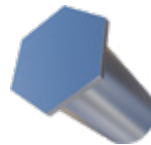
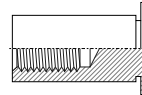

www.trfastenings.com/TR00026983

Through Standoff TR-SO/TR-SOS/TR-SOA/TR-SO4

Category: Self Clinch Fastener

Product: Standoff

Type: Through

Material: Steel (TR-SO), Stainless Steel (TR-SOS), Aluminium (TR-SOA), 400 Stainless Steel (TR-SO4)

Thread: M2, M2.5, M3, M3 Alt, M4, M5

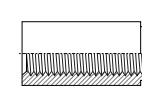

www.trfastenings.com/TR00027907



Concealed Head Standoff for 1.6mm Sheet TR-CSS

Category: Self Clinch Fastener

Product: Standoff

Type: Concealed Head for 1.6mm Sheet

Material: Stainless Steel (TR-CSS)

Thread: M3, M4, M5

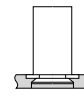
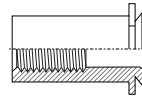

www.trfastenings.com/TR00027804

Concealed Head Standoff for 2.4mm Sheet TR-CSOS

Category: Self Clinch Fastener

Product: Standoff

Type: Concealed Head for 2.4mm min. Sheet

Material: Stainless Steel (TR-CSOS)

Thread: M3, M4, M5, M6

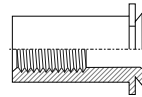

www.trfastenings.com/TR00027822

Hole Slide Standoff TR-SKC

Category: Self Clinch Fastener

Product: Standoff

Type: Hole Slide

Material: Stainless Steel (TR-SKC)

Dia. Code: 61.5

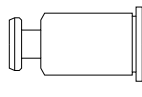

www.trfastenings.com/TR00027851

Close To Edge Standoff TR-DSO/TR-DSOS

Category: Self Clinch Fastener

Product: Standoff

Type: Close To Edge

Material: Steel (TR-DSO), Stainless Steel (TR-DSOS)

Thread: M3

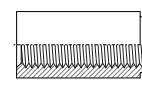

www.trfastenings.com/TR00027898

Grounding Standoff TR-SOSG

Category: Self Clinch Fastener

Product: Standoff

Type: Grounding

Material: Stainless Steel (TR-SOSG)

Thread: M3

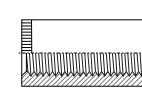

www.trfastenings.com/TR00027844

Clip-on Standoff TR-SSS/TR-SSC/TR-SSA

Category: Self Clinch Fastener

Product: Standoff

Type: Clip-on

Material: Steel (TR-SSS), Stainless Steel (TR-SSC), Aluminium (TR-SSA)

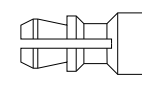

www.trfastenings.com/TR00027722

Broaching Through Hole Standoff TR-KFE/TR-KFSE

Category: Self Clinch Fastener
 Product: Standoff
 Type: Broaching Through Hole
 Material: Steel (TR-KFE), Stainless Steel (TR-KFSE)
 Dia. Code: 3.6mm, 4.2mm

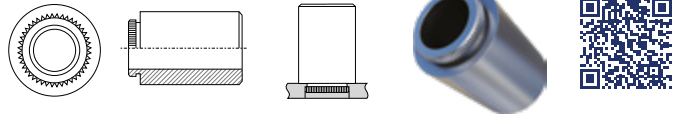

www.trfastenings.com/TR00027617

Broaching Threaded Standoff TR-KFE/TR-KFSE

Category: Self Clinch Fastener
 Product: Standoff
 Type: Broaching Threaded
 Material: Steel (TR-KFE), Stainless Steel (TR-KFSE)
 Thread: M3, M4

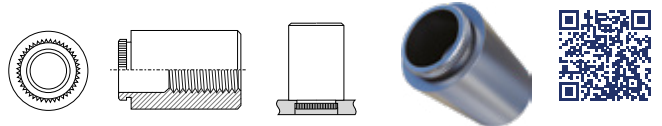

www.trfastenings.com/TR00027512

Thin Sheet Standoff TR-TSO/TR-TSOS

Category: Self Clinch Fastener
 Product: Standoff
 Type: Thin Sheet
 Material: Steel (TR-TSO), Stainless Steel (TR-TSOS)
 Thread: M2.5, M2.5 Alt, M3, M3.5, M3 Alt

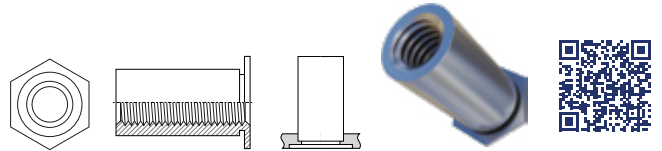

www.trfastenings.com/TR00029582

Clear Hole Standoff TR-SO

Category: Self Clinch Fastener
 Product: Standoff
 Type: Clear Hole
 Material: Steel (TR-SO)
 Dia. Code: 4/3.1mm, 6/3.1mm, 6/3.6mm, 8/3.6mm, 8/4.1mm, 8/5.1mm

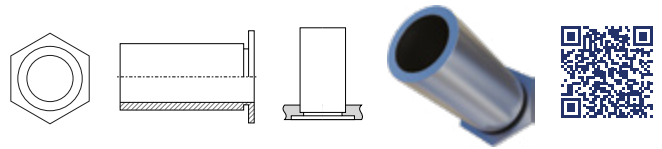

www.trfastenings.com/TR00038794

Slotted Panel Fastener TR-PFS2/TR-PFC2

Category: Self Clinch Fastener
 Product: Panel Fastener
 Type: Slotted
 Material: Steel (TR-PFS2), Stainless Steel (TR-PFC2)
 Thread: M3, M4, M5, M6

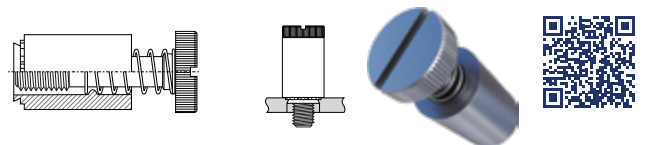

www.trfastenings.com/TR00026861

Cross Recess Panel Fastener TR-PFC2P

Category: Self Clinch Fastener
 Product: Panel Fastener
 Type: Cross Recess
 Material: Stainless Steel (TR-PFC2P)
 Thread: M3, M4, M5, M6

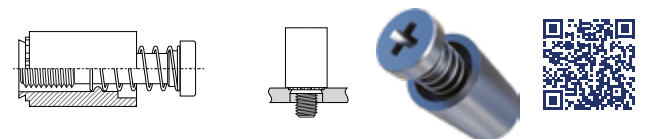

www.trfastenings.com/TR00026805

Self Clinch Fasteners



Low Profile Panel Fastener TR-PF30/TR-PF31/TR-PF32

Category: Self Clinch Fastener

Product: Panel Fastener

Type: Low Profile

Material: Steel (TR-PF30/TR-PF31/TR-PF32)

Thread: M3, M4, M5, M6

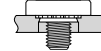
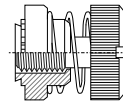

www.trfastenings.com/TR00026834

Pin Panel Fastener TR-PTL2

Category: Self Clinch Fastener

Product: Panel Fastener

Type: Pin

Material: Steel (TR-PTL2)

Dia. Code: 6.35mm (O4)

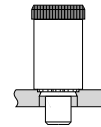
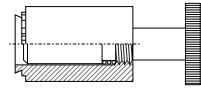

www.trfastenings.com/TR00026858

Captive Screw Panel Fastener TR-PF11

Category: Self Clinch Fastener

Product: Panel Fastener

Type: Captive Screw

Material: Steel Steel, Aluminium, Stainless Steel (TR-PF11)

Thread: M3, M4, M5, M6

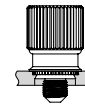
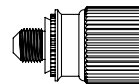

www.trfastenings.com/TR00029809

Captive Screw Panel Fastener TR-PFHV

Category: Self Clinch Fastener

Product: Panel Fastener

Type: Captive Screw

Material: Steel (TR-PFHV)

Thread: M3, M3.5, M4

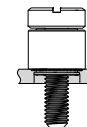
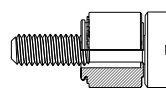

www.trfastenings.com/TR00044347

Low Profile Cross Recess Panel Fastener TR-PF50

Category: Self Clinch Fastener

Product: Panel Fastener

Type: Low Profile Cross Recess

Material: Steel (TR-PF50)

Thread: M3, M4, M5

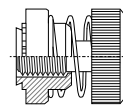

www.trfastenings.com/TR00046710

Flush Head Pin TR-TP/TR-TPS/TR-TP4

Category: Self Clinch Fastener

Product: Pin

Type: Flush Head

Material: Steel (TR-TP), Stainless Steel (TR-TPS), 400 Stainless Steel (TR-TP4)

Pin Dia: 3mm, 4mm, 5mm, 6mm

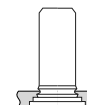
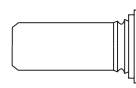

www.trfastenings.com/TR00026918

Self Clinch Fasteners



Terminal Pin TR-TER

Category: Self Clinch Fastener

Product: Pin

Type: Terminal Pin

Material: Steel (TR-TER)

Width: 8mm

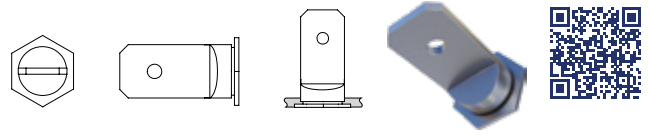

www.trfastenings.com/TR00029823

Cable Tie Mount TR-TD

Category: Self Clinch Fastener

Product: Mount

Type: Cable Tie Mount

Material: Steel (TR-TD)

Size: TR-TD-40-4, TR-TD-60-6, TR-TD-175-12

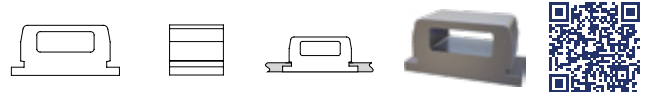

www.trfastenings.com/TR00029819

EPW Self-Extruding Screw TR-EPW

Category: Sheet Metal Fastener

Product: Self Extruding High Strength Screw for Thin Sheet Metal

Type: Pan Head, Pan Flange Head

Material: Case Hardened Mild Steel

Size: M3.5, M4, M5



www.trfastenings.com/products/product-innovation/epw-screw



The TR
Media
Library

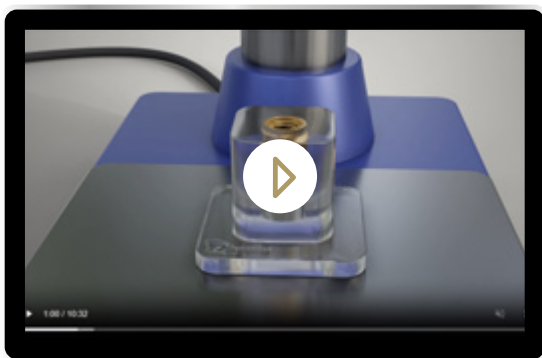

Explore TR Fastenings' media library for a comprehensive understanding of our wide range of fastening products and manufacturing processes. Access videos and resources tailored for engineers, designers and specifiers.



3D Product
Visualisers

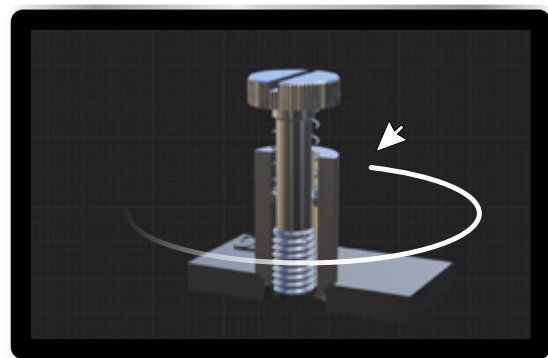

TR's Product Visualisers assist companies at the design stage. A range of options enables the user to interact with the products in a variety of ways such as assemblies, cutaways, magnification, material types and installation. It's intuitive, clear and a great training tool too!



Round Serrated Face Rivet Bush

Category: Rivet Bush
 Product: Round
 Type: Serrated Face
 Material: Steel, Stainless Steel, Brass, Aluminium
 Thread: M2.5, M3, M3.5, M4, M5, M6, M8, M10, M12

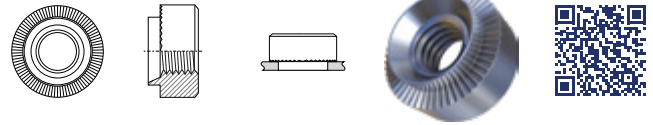

www.trfastenings.com/TR00024998

Mini Round Serrated Face Rivet Bush

Category: Rivet Bush
 Product: Round
 Type: Mini Serrated Face
 Material: Steel, Stainless Steel, Brass, Aluminium
 Thread: M2, M2.5, M3, M3.5, M4, M5, M6, M8, M10, M12

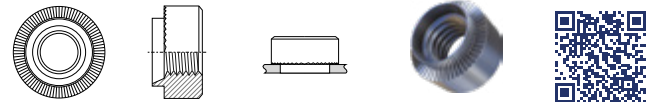

www.trfastenings.com/TR00023292

Round Serrated Spigot Rivet Bush

Category: Rivet Bush
 Product: Round
 Type: Serrated Spigot
 Material: Steel, Stainless Steel, Brass, Aluminium
 Thread: M2.5, M3, M3.5, M4, M5, M6, M8, M10, M12

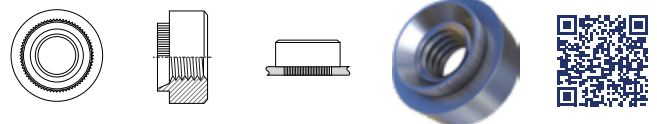

www.trfastenings.com/TR00025127

Hexagon Rivet Bush

Category: Rivet Bush
 Product: Hexagon
 Type: Rivet Bush
 Material: Steel, Stainless Steel
 Thread: M2.5, M3, M3.5, M4, M5, M6, M8, M10, M12

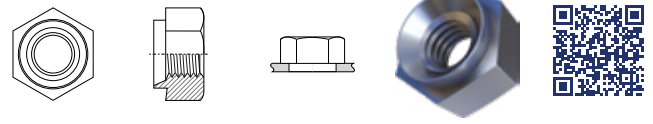

www.trfastenings.com/TR00023122

Mini Round Euro Rivet Bush

Category: Rivet Bush
 Product: Round
 Type: Mini Euro
 Material: Steel
 Thread: M3, M4, M5, M6

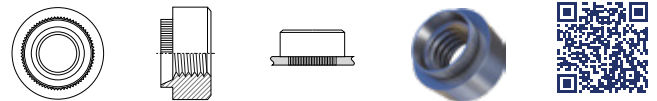

www.trfastenings.com/TR00023262

Round Euro Rivet Bush

Category: Rivet Bush
 Product: Round
 Type: Euro
 Material: Steel
 Thread: M3, M4, M5, M6, M8

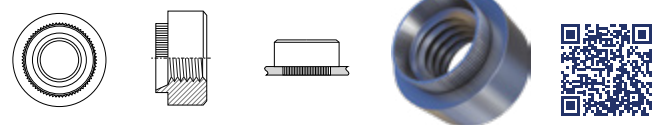

www.trfastenings.com/TR00024966



Standoff Serrated Face Rivet Bush

Category: Rivet Bush
 Product: Standoff
 Type: Serrated Face
 Material: Steel, Stainless Steel
 Thread: M2.5, M3, M3.5, M4, M5, M6, M8, M10, M12

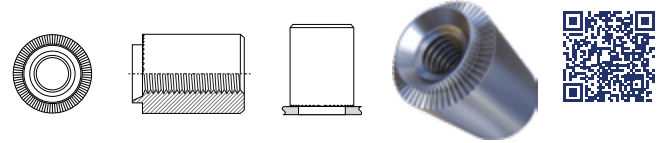

www.trfastenings.com/TR00025272

Mini Standoff Serrated Face Rivet Bush

Category: Rivet Bush
 Product: Standoff
 Type: Mini Serrated Face
 Material: Steel, Stainless Steel
 Thread: M2, M2.5, M3, M3.5, M4, M5, M6, M8, M10, M12

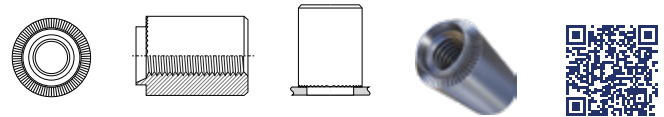

www.trfastenings.com/TR00023513

Tank Rivet Bush

Category: Rivet Bush
 Product: Round
 Type: Tank
 Material: Steel, Stainless Steel
 Thread: M3, M4, M5, M6, M8, M10, M12



www.trfastenings.com/TR00026646

Swage Nut Rivet Bush

Category: Rivet Bush
 Product: Round
 Type: Swage Nut
 Material: Steel, Stainless Steel
 Thread: M3, M4, M5, M6, M8

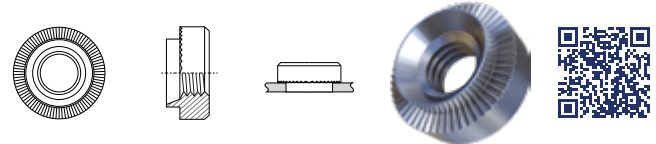

www.trfastenings.com/TR00026575

Technical support services

TR Knowledge Base

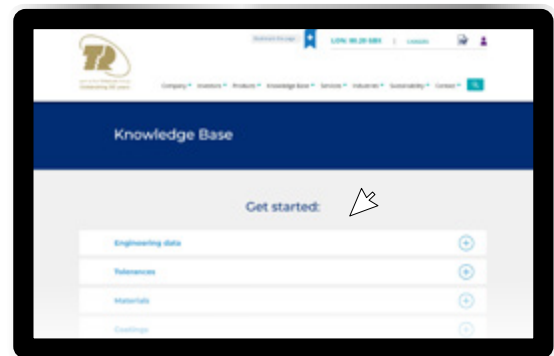



Knurled Body Reduced Head Open End

Category: Blind Rivet Nut
 Product: Reduced Head - REDE
 Type: Knurled Body - Open End
 Material: Steel, Stainless Steel
 Thread: M3, M4, M5, M6, M8, M10

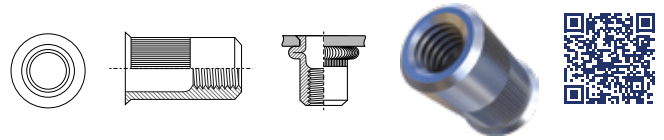

www.trfastenings.com/TR00022074

Knurled Body Reduced Head Closed End

Category: Blind Rivet Nut
 Product: Reduced Head - REDE
 Type: Knurled Body - Closed End
 Material: Steel
 Thread: M4, M5, M6, M8, M10

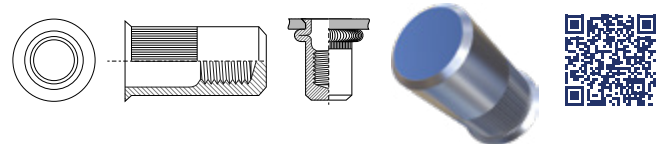

www.trfastenings.com/TR00045679

Plain Body Reduced Head Open End

Category: Blind Rivet Nut
 Product: Reduced Head - REDE
 Type: Plain Body - Open End
 Material: Steel, Stainless Steel
 Thread: M3, M4, M5, M6, M8, M10

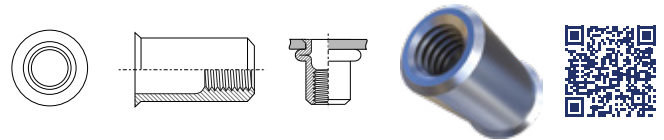

www.trfastenings.com/TR00022098

Plain Body Reduced Head Closed End

Category: Blind Rivet Nut
 Product: Reduced Head - REDE
 Type: Plain Body - Closed End
 Material: Steel
 Thread: M4, M5, M6, M8, M10

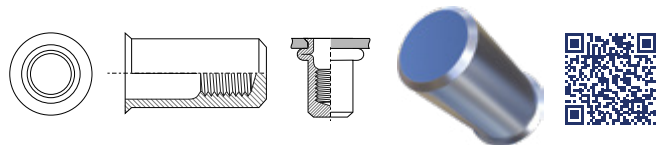

www.trfastenings.com/TR00045685

Hexagon Body Reduced Head Open End

Category: Blind Rivet Nut
 Product: Reduced Head - REDE
 Type: Hexagon Body - Open End
 Material: Steel, Stainless Steel
 Thread: M4, M5, M6, M8, M10

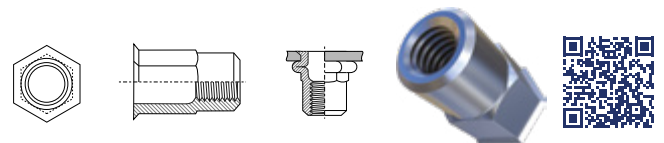

www.trfastenings.com/TR00022120

Knurled Body Flange Head Open End

Category: Blind Rivet Nut
 Product: Flange Head- FLG
 Type: Knurled Body - Open End
 Material: Steel, Stainless Steel
 Thread: M3, M4 Medium, M4 Short, M5 Medium, M5 Short, M6 Medium, M6 Short, M8 Medium, M8 Short, M10 Medium, M10 Short, M12

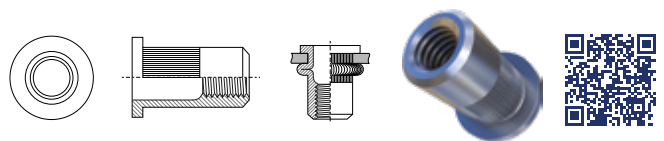

www.trfastenings.com/TR00022139



Knurled Body Flange Head Closed End

Category: Blind Rivet Nut
 Product: Flange Head - FLG
 Type: Knurled Body - Closed End
 Material: Steel, Stainless Steel
 Thread: M3, M4, M5, M6, M8, M10

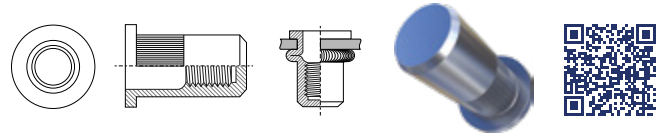

www.trfastenings.com/TR00022158

Hexagon Body Flange Head Open End

Category: Blind Rivet Nut
 Product: Flange Head - FLGXE
 Type: Hexagon Body - Open End
 Material: Steel, Stainless Steel
 Thread: M4, M5, M6, M8, M10

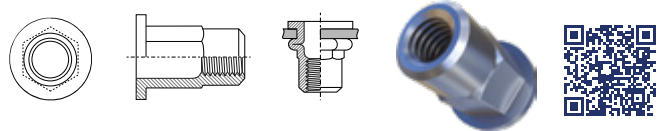

www.trfastenings.com/TR00022171

Knurled Body Countersunk Head Open End

Category: Blind Rivet Nut
 Product: Countersunk Head - CSK
 Type: Knurled Body - Open End
 Material: Steel, Stainless Steel
 Thread: M4, M5, M6, M8, M10

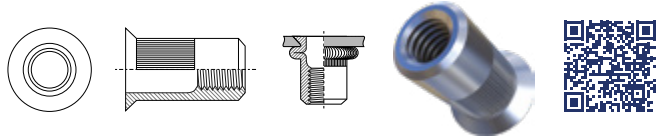

www.trfastenings.com/TR00022182

TR product news

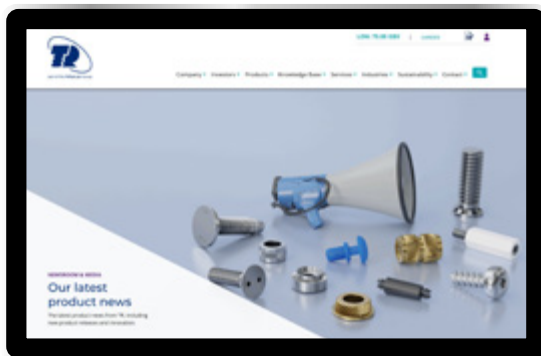

TR sustainability



Blind Rivets



Open Type Dome Head

Category: Blind Rivet
Product: Open Type
Type: Dome Head
Material: Aluminium (AlMg3.5/2.5/5), Steel, Stainless Steel, Copper

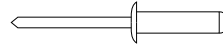

www.trfastenings.com/TR00022193

Open Type Countersunk Head

Category: Blind Rivet
Product: Open Type
Type: Countersunk Head
Material: Aluminium (AlMg3.5), Steel, Stainless Steel

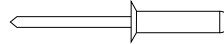

www.trfastenings.com/TR00022539

Open Type Large Flange Head

Category: Blind Rivet
Product: Open Type
Type: Large Flange Head
Material: Aluminium (AlMg3.5/5), Steel, Stainless Steel

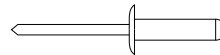

www.trfastenings.com/TR00022678

Sealed Type Dome Head

Category: Blind Rivet
Product: Sealed Type
Type: Dome Head
Material: Aluminium (AlMg5), Steel, Stainless Steel, Copper

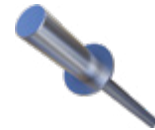
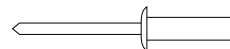

www.trfastenings.com/TR00022813

Sealed Type Countersunk Head

Category: Blind Rivet
Product: Sealed Type
Type: Countersunk Head
Material: Aluminium (AlMg5), Steel

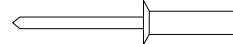

www.trfastenings.com/TR00022932

Sealed Type Large Flange Head

Category: Blind Rivet
Product: Sealed Type
Type: Large Flange Head
Material: Aluminium (AlMg5), Steel, Stainless Steel

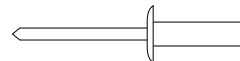

www.trfastenings.com/TR00022949

Multi-Grip Type Dome Head

Category: Blind Rivet
Product: Multi-Grip Type
Type: Dome Head
Material: Aluminium, Steel, Stainless Steel

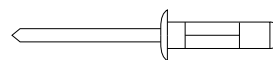

www.trfastenings.com/TR00022969

Blind Rivets



Multi-Grip Type Countersunk Head

Category: Blind Rivet

Product: Multi-Grip Type

Type: Countersunk Head

Material: Aluminium, Steel

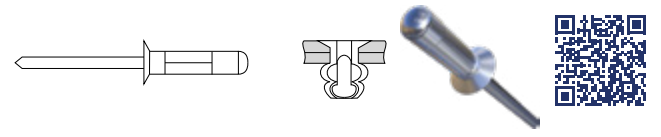

www.trfastenings.com/TR00023030

Multi-Grip Type Large Flange Head

Category: Blind Rivet

Product: Multi-Grip Type

Type: Large Flange Head

Material: Aluminium, Steel

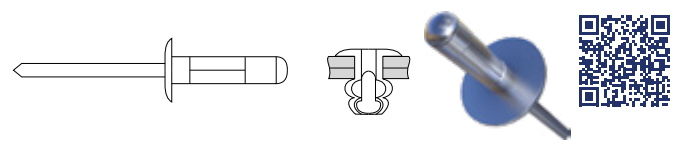

www.trfastenings.com/TR00023056

Peel Type Dome Head

Category: Blind Rivet

Product: Peel Type

Type: Dome Head

Material: Aluminium, Steel

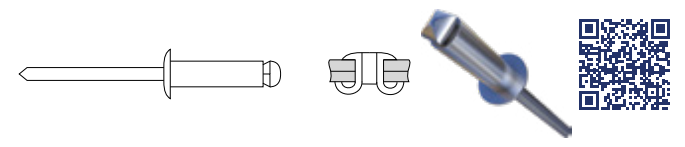

www.trfastenings.com/TR00023080

Grooved Type Dome Head

Category: Blind Rivet

Product: Grooved Type

Type: Dome Head

Material: Aluminium (AlMg3.5), Steel

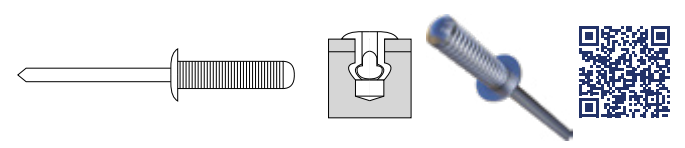

www.trfastenings.com/TR00023103

 TR sectors 

 TR press releases 



Weld Nuts



Hexagon Weld Nut

Category: Weld Nut
Type: Hexagon
Standard: DIN 929
Material: Steel, Stainless Steel, A4 Stainless Steel
Thread: M3, M4, M5, M6, M8, M10, M12, M14, M16

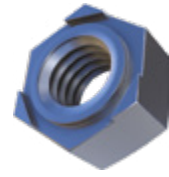
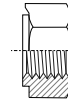

www.trfastenings.com/TR00001213

Square Weld Nut

Category: Weld Nut
Type: Square
Standard: DIN 928
Material: Steel, Stainless Steel
Thread: M4, M5, M6, M8, M10, M12

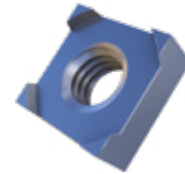
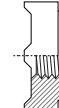
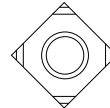

www.trfastenings.com/TR00001237

Wun-Loc® Self Locking Weld Nut

Category: Weld Nut
Type: Wun-Loc® Self Locking
Material: Steel
Thread: M4, M5, M6, M8, M10, M12

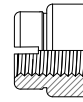
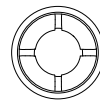

www.trfastenings.com/TR00035601

K-Series® Nuts



K-Series® Nut

Category: Nut
Product: K-Series®
Type: Hexagon
Material: Steel, Stainless Steel
Thread: M2.5, M3, M4, M5, M6, M8, M10, M12, M16, M20

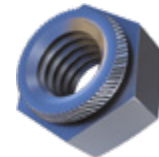

www.trfastenings.com/TR00035866

K-Series® Thin Nut

Category: Nut
Product: K-Series® Thin
Type: Hexagon
Material: Steel
Thread: M8, M10, M12

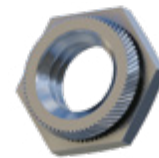
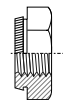

www.trfastenings.com/TR00046717

Wun-Loc® is a registered trademark of TR Fastenings.

CD Weld Studs



Threaded CD Weld Stud

Category: CD Weld Nut
Type: Threaded
Standard: DIN EN ISO 13918
Material: Steel, Stainless Steel, Aluminium
Thread: M3, M4, M5, M6, M8

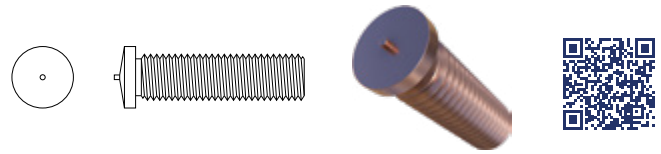

www.trfastenings.com/TR00036039

Unthreaded CD Weld Stud

Category: CD Weld Nut
Type: Unthreaded
Standard: DIN EN ISO 13918
Material: Steel, Stainless Steel
Thread: 3mm, 4mm, 5mm, 6mm, 7.1mm



www.trfastenings.com/TR00036189

Internally Threaded CD Weld Stud

Category: CD Weld Nut
Type: Internally Threaded
Standard: DIN EN ISO 13918
Material: Steel
Thread: M3, M4, M5

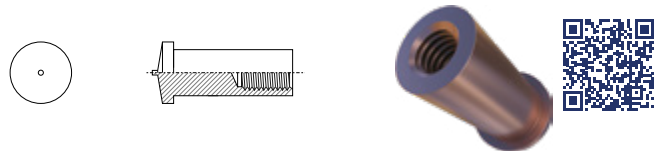

www.trfastenings.com/TR00036252

Coarse Threaded CD Weld Stud

Category: CD Weld Nut
Type: Coarse Threaded
Standard: DIN EN ISO 13918
Material: Steel
Thread: 5mm

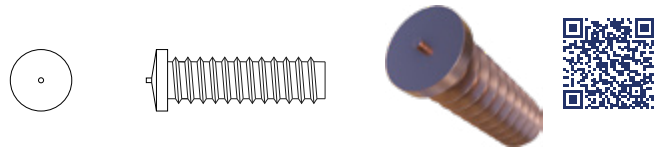

www.trfastenings.com/TR00036273

Masking Caps & Plugs



Masking Caps

Category: Masking Caps and Plugs
Product: Cap
Material: Silicon
To suit thread: M3, M4, M5, M6, M8



www.trfastenings.com/TR00038867

Masking Plugs

Category: Masking Caps and Plugs
Product: Plug
Material: Silicon
To suit thread: M3, M3/M4, M4/M5/M6, M6/M8, M8, M8/M10



www.trfastenings.com/TR00038879



Cage Nut

Category: Spring Steel Fasteners
 Product: Nut
 Type: Cage
 Material: Steel
 Thread: M4, M5, M6, M8, M10

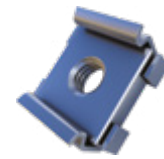
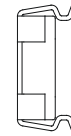
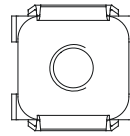

www.trfastenings.com/TR00035907

U Nut

Category: Spring Steel Fasteners
 Product: Nut
 Type: U
 Material: Steel
 Thread: 2.9mm (no.4), 3.5mm (no.6), 4.2mm (no.8), 4.8mm (no.10), 5.5mm (no.12), 6.3mm (no.14), 7.0mm (no.16)

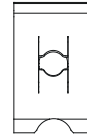

www.trfastenings.com/TR00035935

J Nut

Category: Spring Steel Fasteners
 Product: Nut
 Type: J
 Material: Steel
 Thread: 3.5mm (no.6), 4.2mm (no.8), 4.8mm (no.10), 5.5mm (no.12), 6.3mm (no.14)

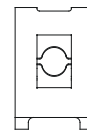

www.trfastenings.com/TR00035920

Flat Nut

Category: Spring Steel Fasteners
 Product: Nut
 Type: Flat
 Material: Steel
 Thread: 3.5mm (no.6), M4, 4.2mm (no.8), M5, M6, 6.3mm

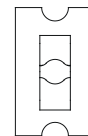

www.trfastenings.com/TR00035990

Torque Nut

Category: Spring Steel Fasteners
 Product: Nut
 Type: Torque
 Material: Steel
 Thread: 3.5mm (no.6), 4.2mm (no.8), 4.8mm (no.10), 5.5mm (no.12), 6.3mm (no.14)

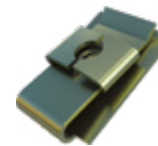
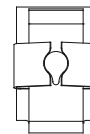

www.trfastenings.com/TR00035978

Multi Thread U Nut

Category: Spring Steel Fasteners
 Product: Nut
 Type: Multi Thread U
 Material: Steel
 Thread: M3, M4, M5, M6, M8, M10, M12

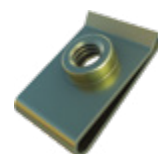
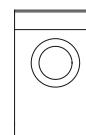

www.trfastenings.com/TR00036000



Round Head Solid Rivet

Category: Solid & Tubular Rivets
 Product: Round Head
 Type: Solid
 Material: Steel, Stainless Steel, Aluminium, Copper
 Standard: DIN 124

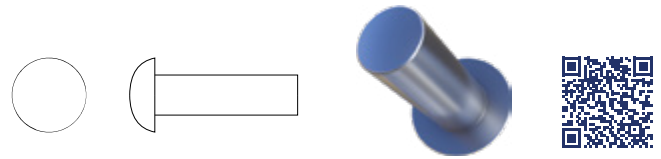

www.trfastenings.com/TR00030337

Flat Round Head Solid Rivet

Category: Solid & Tubular Rivets
 Product: Flat Round Head
 Type: Solid
 Material: Steel, Aluminium, Copper
 Standard: DIN 674

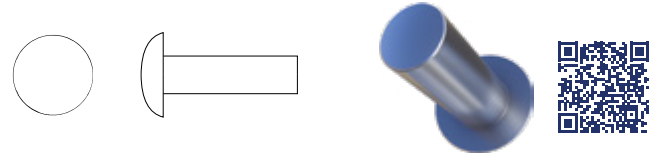

www.trfastenings.com/TR00030257

Countersunk Head Solid Rivet

Category: Solid & Tubular Rivets
 Product: Countersunk Head
 Type: Solid
 Material: Stainless Steel
 Standard: DIN 661

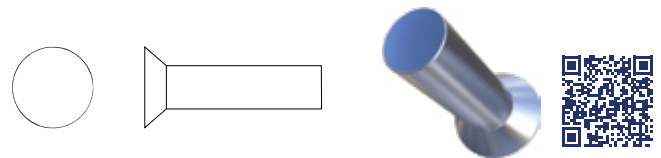

www.trfastenings.com/TR00030242

Tubular Rivet

Category: Solid & Tubular Rivets
 Product: Tubular
 Type: Tubular
 Material: Brass
 Standard: DIN 7340A

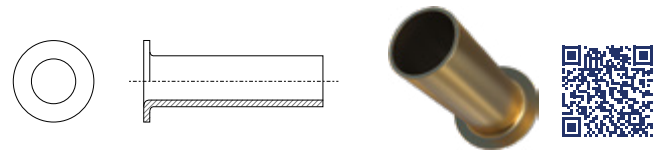

www.trfastenings.com/TR00030514

Supply chain solutions

Investor news

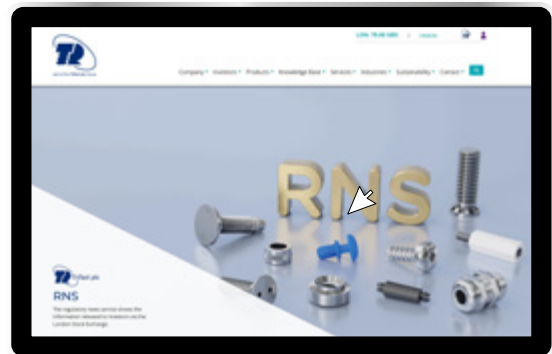
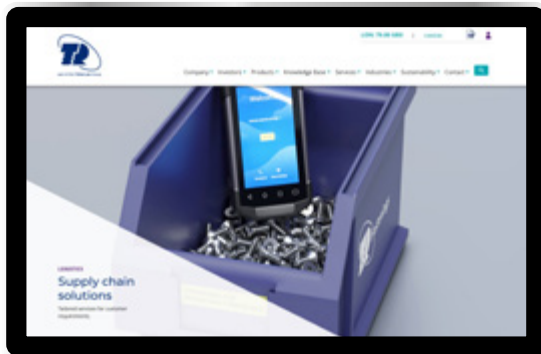



Standard Fasteners

We stock and supply a vast range of standard fasteners to DIN, ISO & ANSI standards including:

- Machine Screws
- Self Tapping Screws
- Thread Forming Screws
- Socket Products
- Nuts
- Washers



Fasteners for Plastic

Screws For Plastic

- Plas-Tech 30-20®
- Plas-Tech® 30
- Plas-Fix® 45 + 60
- Thread Cutting Type BT + Y
- Hi-Lo Thread
- JCIS P-type M1.4 to M2.6
- JCIS B-type M1.4 to M2.6

Inserts For Plastic

- Sonic-Sert, Heat-Sert
- Broaching-Sert
- Expansion-Sert
- Tech-Sert and more ...



Plastic Hardware

- Circuit Board Hardware
- Cable Management
- Rivets
- Machine Screws
- Threaded Spacers
- Threaded Pillars
- Nuts
- Through Spacers
- Washers
- Bumpers
- Masking Caps And Plugs



Spacers and Pillars

Threaded Spacers

- Hexagon Female-Female
- Round Female-Female

Threaded Pillars

- Hexagon Male-Female
- Hexagon Male-Male
- Round Male-Female
- Hexagon Self Tapping Male-Female

Through Spacers





Security Fasteners

Machine Screws

Self Tapping Screws
Wood Screws
Self Drilling Screws
Nuts

Drive Types:

Pin Hexagon
Pin Recess Torx® Drive
2 Hole
One Way Cross Recess
Oval
Triangular
One Way Slot and more ...

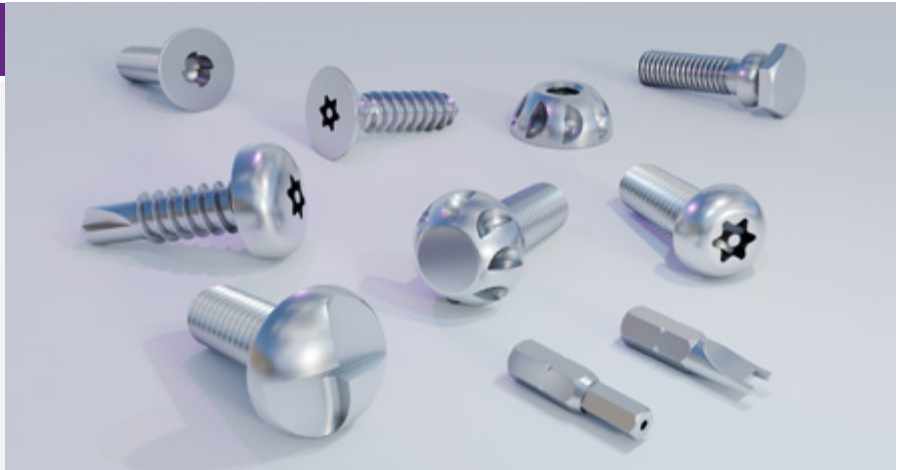

Enclosure Hardware

Locking Systems
Locks
Lock Components
Hinges
Latches
Clamps
Terminals
Gaskets
Handles
Accessories



Tooling and Driver Bits

Standard driver bits

Hexagon - short/long
PoziDriv® - short/long
H Drive - short/long
Torx® - short/long

Standard driver keys

Hexagon
Hexagon With Pilot
Torx®

Security drivers

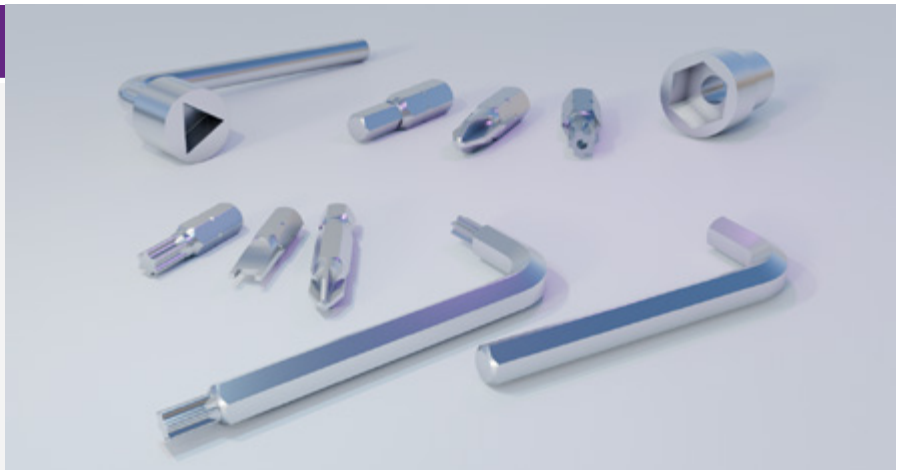

Bespoke Products

Our factories in Asia and Europe produce components which are specifically tailored to customer drawings. In addition, our strategic partnerships with other world-class manufacturers, allow us to offer a wide range of practically any size of turned, cold-formed, pressed or moulded components.



Where we operate

Key:

- Head office Trifast plc
- TR Asia headquarters
- Manufacturing, sales & distribution
- Sales & distribution
- Sales office
- Engineering & innovation centre
- Joint Venture (manufacturing)

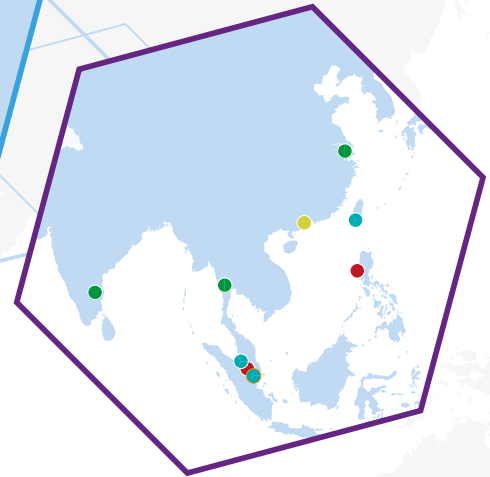
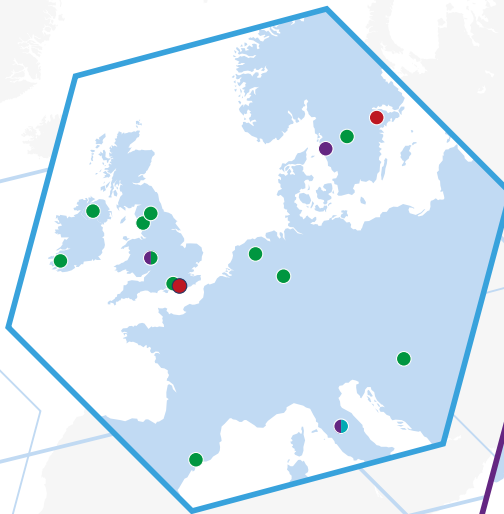
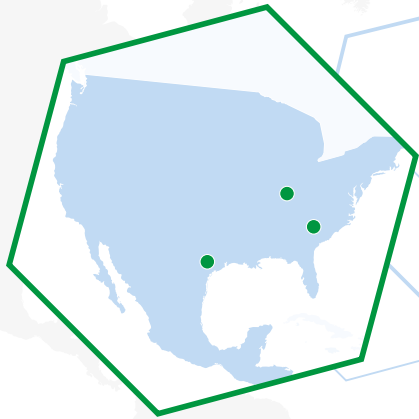

UK

t: +44 (0)8454 811 800
e-mail: uk@trfastenings.com

Ireland

t: +353 (0)22 22301
e-mail: ireland@trfastenings.com

Netherlands

t: +31 (0)541 511515
e-mail: netherlands@trfastenings.com

Sweden

t: +46 (0)8 578 44 900
e-mail: sweden@trfastenings.com

Spain

t: +34 93 647 22 45
e-mail: spain@trfastenings.com

Hungary

t: +36 30 342 1218
e-mail: hungary@trfastenings.com

Poland - Representative

t: +48 (22)402 36 14
e-mail: poland@trfastenings.com

Italy

t: +39 (0)75 9149015
e-mail: info@trvic.it

Germany

t: +49 (0) 5246 . 50320 - 0
e-mail: info@trkuhlmann.com

USA

Houston - t: +1 800-280-2181
Charlotte - t: +1 704-588-4740
e-mail: usa@trfastenings.com

Singapore

t: +65 6759 6033
e-mail: singapore@trfastenings.com

Japan - Representative

t: +86(0)21 5032 6559
e-mail: wudeqing@trformac.com.cn

Malaysia

t: +6 (03) 5519 1444
e-mail: psep@psep.com.my

China

t: +86 21 5032 5696
e-mail: china@trfastenings.com

Taiwan

t: +886 7 557 6366
e-mail: taiwan@trfastenings.com

Philippines - Representative Office

t: +63-25768476
e-mail: philippines@trfastenings.com

India

t: +91 (0)44 4280 3932
e-mail: india@trfastenings.com

Thailand

t: +66(0)2 130 6562
e-mail: thailand@trfastenings.com



Engineering & innovation centres

Birmingham - UK

t: +44 (0)121 521 0000
e-mail: wednesbury@trfastenings.com
sales@trfastenings.com

Gothenburg - Sweden

t: +46 (0)31 31 760 776
e-mail: sweden@trfastenings.com
www.trfastenings.com

Italy

t: +39 (0)75 9149015
e-mail: info@trvic.it
www.trfastenings.com



Master Distributor Details

